

# Laurel Electronics, Inc.

3183-G Airway Avenue, Costa Mesa, CA 92626  
Tel 714 434-6131 Fax 714 434-3766  
www.laurels.com

---

## Triple output loop splitter

# TLS-A

## Connection details and general information

---

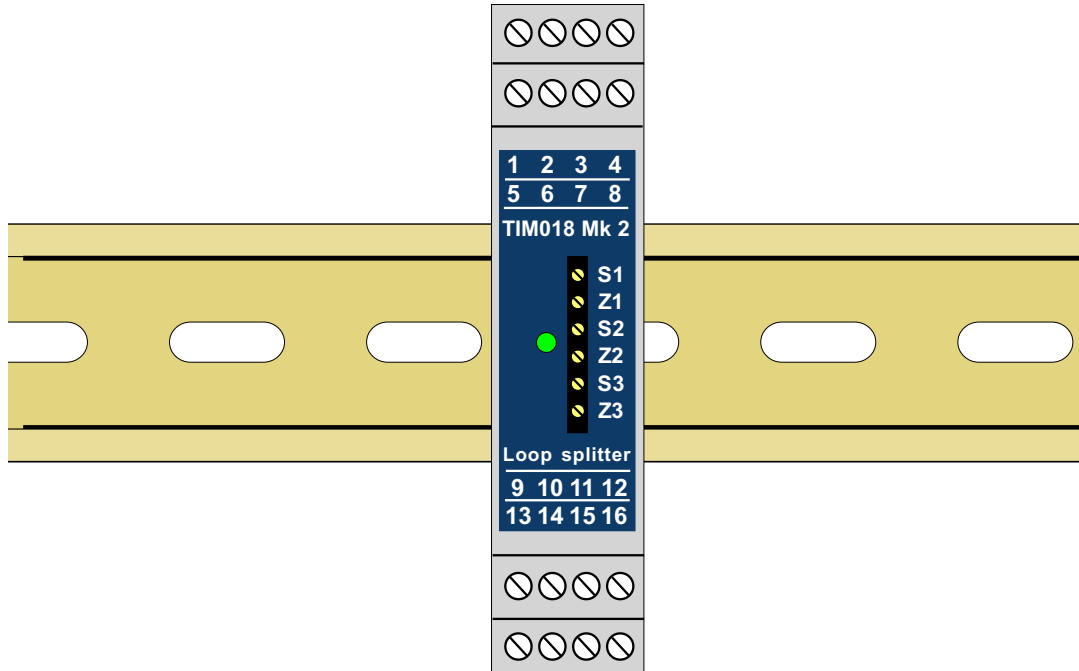



# Alphabetic Index

Block diagram	page 8
Connections	
Input 4-20mA active source	page 9
Input 4-20mA 2 wire source	page 10
Input 4-20mA 3 wire source	page 11
Outputs 4-20mA	page 14
Power supply - 95-265 VAC	page 12
Power supply - 11-30 VDC	page 13
Calibration of each output	page 15
Dimensions and weights	page 6
Introduction	page 4
Mounting and removal	page 7
Specifications	page 16
Warnings	page 5

# Introduction

Please contact us if you need help, if you have a complaint, or if you have suggestions to help us improve our products or services for you.

If you contact us about a product you already have, please tell us the full model number, serial number, and software version, so that we can give you accurate and fast help. You can check the **software version** when you first switch on the transmitter. The power LED will blink in 2 groups of flashes. Count the flashes in the 1st group and then in the second group. If you see 1 flash in the 1st group and 3 in the second group, the software version is 1.3

This product has a 2 year warranty. We will put right or replace any item which is faulty because of bad workmanship or materials. This warranty does not cover damage caused by misuse or accident.

## **IMPORTANT**

If this equipment is important to your process, you may want to buy a spare to cover possible failure or accidental damage in the future.

This is because at some times, for example during our factory shutdown periods, you may have to wait several weeks for an equivalent replacement. Or, we may have no stock at the time you urgently need it.

You may also need to pay extra shipping charges if you want a fast, guaranteed courier service. Warranty repairs or replacements are normally returned with a standard courier service.

We do not offer any compensation for losses caused by failure of this instrument.

If you do not agree with these conditions, please return this item now, in unused, clean condition, in its original packaging and we will refund the purchase price, excluding any carriage paid.

We thought you'd prefer to know about possible delays and extra charges now, rather than during a panic.

We always try to improve our products and services, so these may change over time. You should keep this manual safely, because future manuals, for new designs, may not describe this product accurately.

We believe these instructions are accurate, and that we have competently designed and manufactured the product, but please let us know if you find any errors.



# Warnings

**Please carefully read all warnings and ONLY install the item when you are sure that you've covered all aspects.**

- \* Connect the equipment according to current IEE regulations and separate all wiring according to IEC1010.
- \* Power supplies to this equipment must have anti-surge (T) fuses rated at 250mA for AC supply or 1A for DC supplies in the range 11-30VDC.
- \* Check that the model number and supply voltage suit your application before you install the equipment.
- \* Don't touch any circuitry after you have connected the equipment, because there may be lethal voltages on the circuit board or connector terminals.
- \* We designed this equipment for Pollution-Degree 2 environments only. This means you must install it in a clean, dry environment.
- \* Only adjust on-board switches or connections with the power turned off.
- \* Make sure all screw terminals are tight before you switch the equipment on.
- \* Only clean the equipment with a soft dry lint-free cloth. Do not use any solvents.

***Safety First .....Don't assume anything..... Always double check.  
If in doubt, ask someone who is QUALIFIED to help you in the subject.***

# Dimensions and weights

Case (stacking) width	: 22.5	mm
Case forward projection	: 111.0	mm
Case height	: 99.0	mm
Typical transmitter weight	: 200	grams
Operating conditions	: 0 to 50 degrees C , 10 to 90%rh non-condensing	
Storage conditions	: -20 to +70 degrees C, 10 to 90%rh non condensing	
Case sealing	: IP40	
Case Material	: Polyamide PA 6.6	
Cable dimensions	: Accepts multistrand wires total area from 1mm <sup>2</sup> to 4mm <sup>2</sup>	
Flammability Class	: V0 (UL94)	

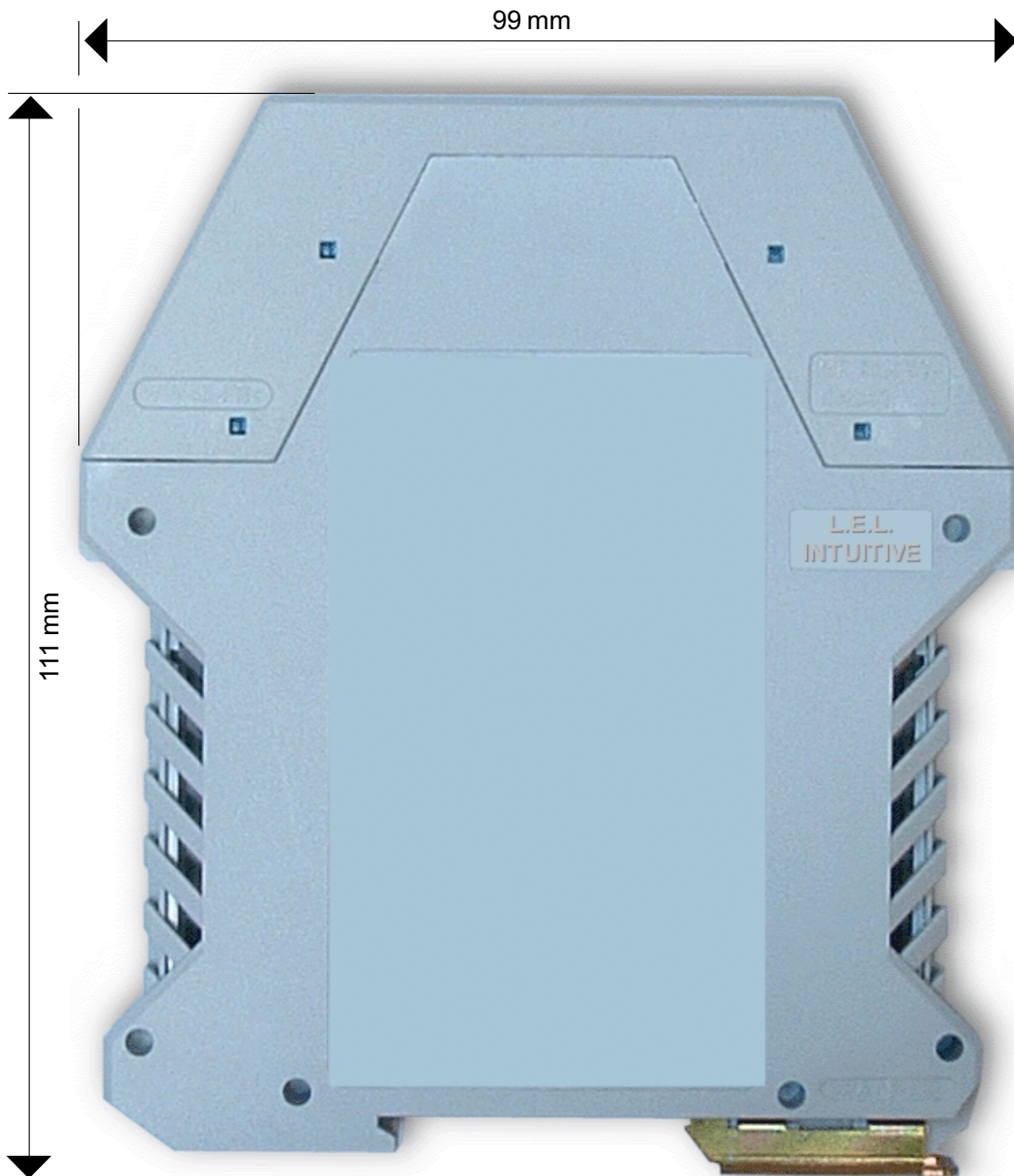

# DIN rail mounting & removal

The TLS-A mounts simply and quickly onto DIN rail in accordance with EN 60 715. Simply clip the housing onto the rail.

To prevent side to side movement, you may also wish to add end-stops, which we can supply as a pair. Ask for accessory XSTOP for plastic end-stops or XEARTH for metal stops with earthing terminal.

## Cooling:

Single splitters are rated for use in still air at 0 to 50 degreesC.

However, as you stack units together, they will gain heat, which you must remove with forced air ventilation.



1 unit, natural ventilation  
0-50C



2 units, natural ventilation  
0-40C

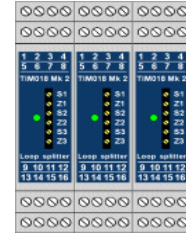

3 or more units, natural ventilation  
0-35C

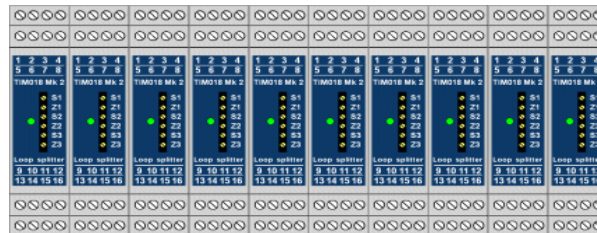

Any number of units, ventilated with air from underneath at  $>0.5\text{ms}^{-1}$   
0-50 C Use a crossflow or tangential blower

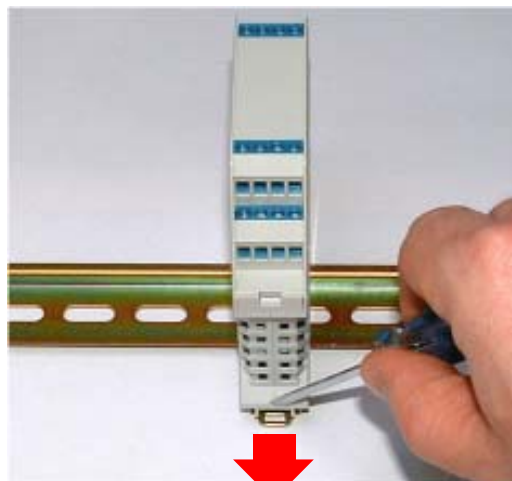

To remove a module, place the tip of a 3mm terminal screwdriver in the slotted metal clip at the base. Pull the clip downwards, and lift the module off the rail.

# Block diagram

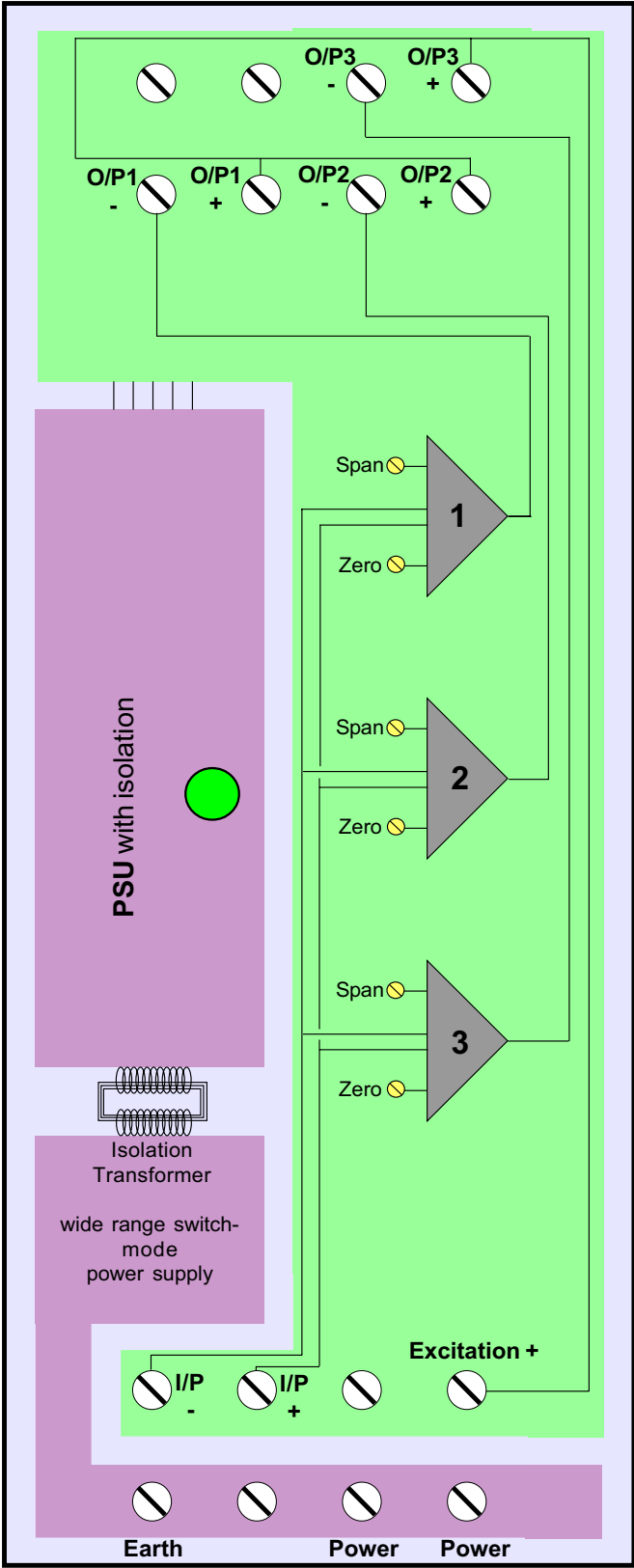

# 4-20mA Input - Active source

Where to connect 4-20mA input if the input does not need excitation

Notes:

Terminal 9 = Signal -

Terminal 10 = Signal +

Terminal 11 = not used

Terminal 12 = Excitation +

Excitation voltage is 20V DC +/-10%

Maximum current 30mA

Input resistance 50 Ohms

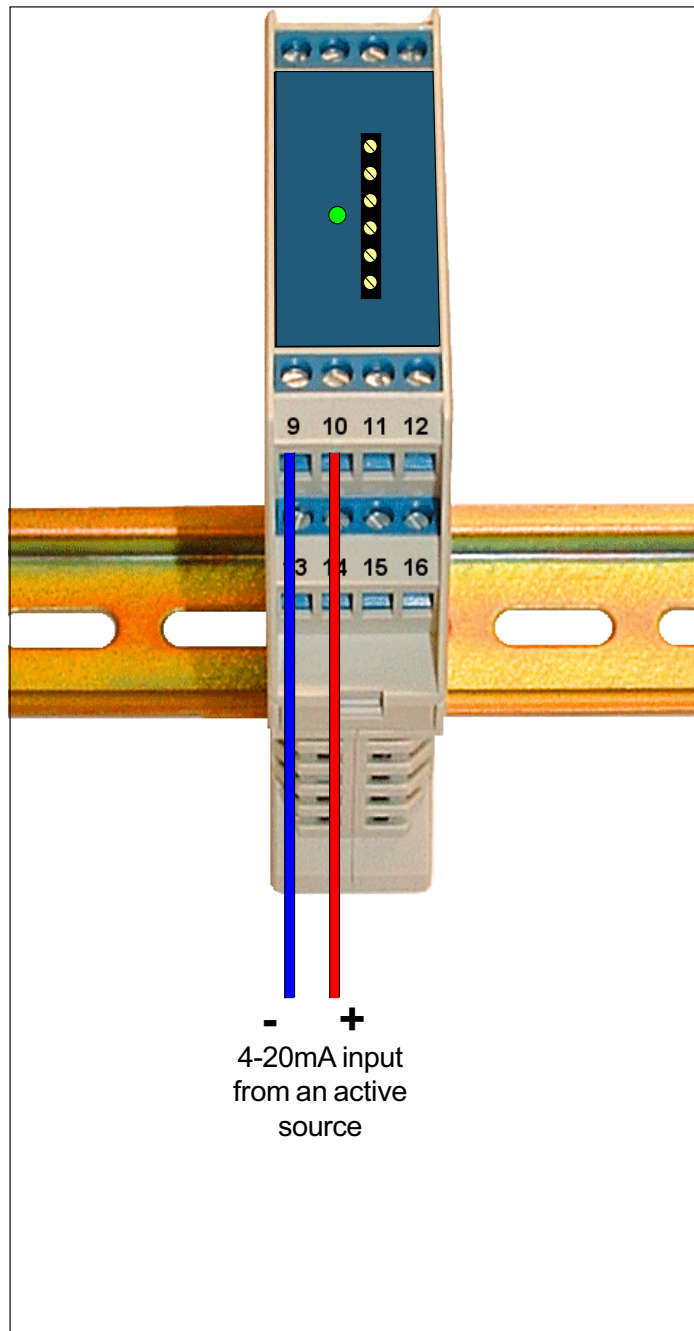

# 4-20mA Input - 2 wire source

Where to connect 4-20mA input if the input comes from a 2 wire transmitter

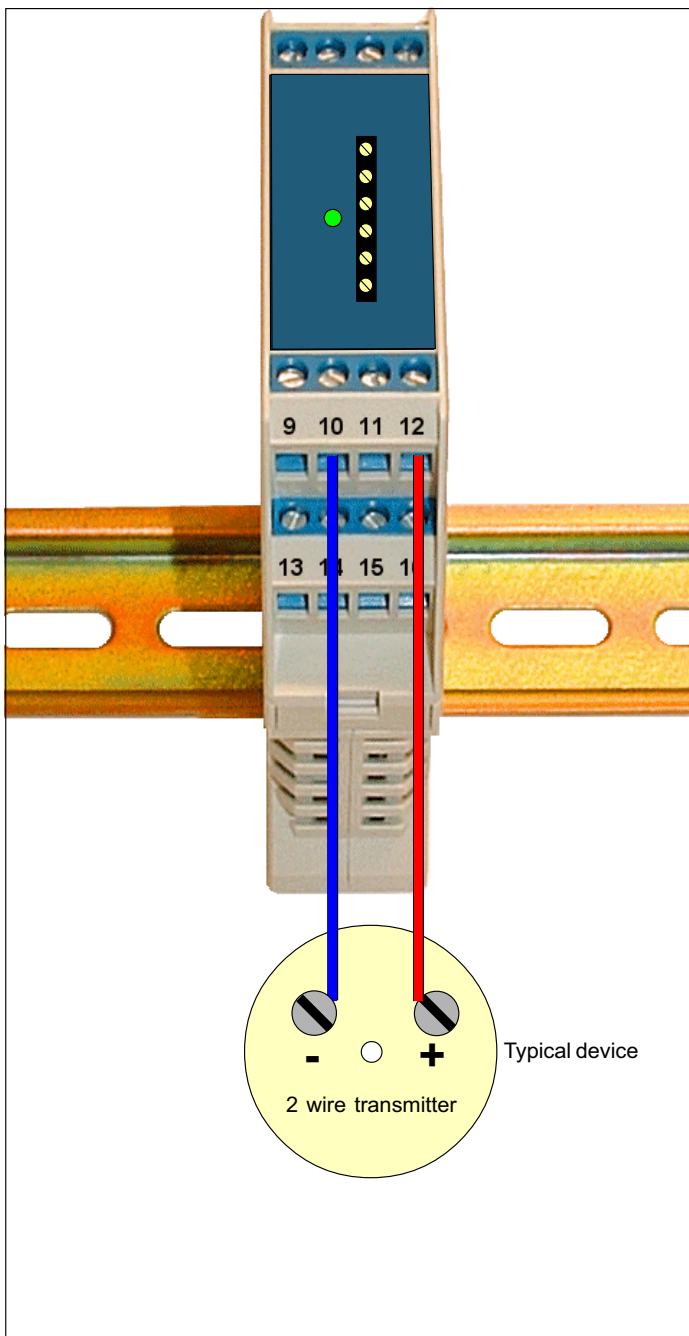

Notes: \_\_\_\_\_  
Terminal 9 = not used  
Terminal 10 = Signal +  
Terminal 11 = not used  
Terminal 12 = Excitation +

Excitation voltage is 20V DC +/-10%  
Maximum current 30mA

Input resistance 50 Ohms

# 4-20mA Input - 3 wire source

Where to connect 4-20mA input if the input comes from a 3 wire transmitter

Notes:

Terminal 9 = Signal -

Terminal 10 = Signal +

Terminal 11 = not used

Terminal 12 = Excitation +

Excitation voltage is 20V DC +/-10%

Maximum current 30mA

Input resistance 50 Ohms

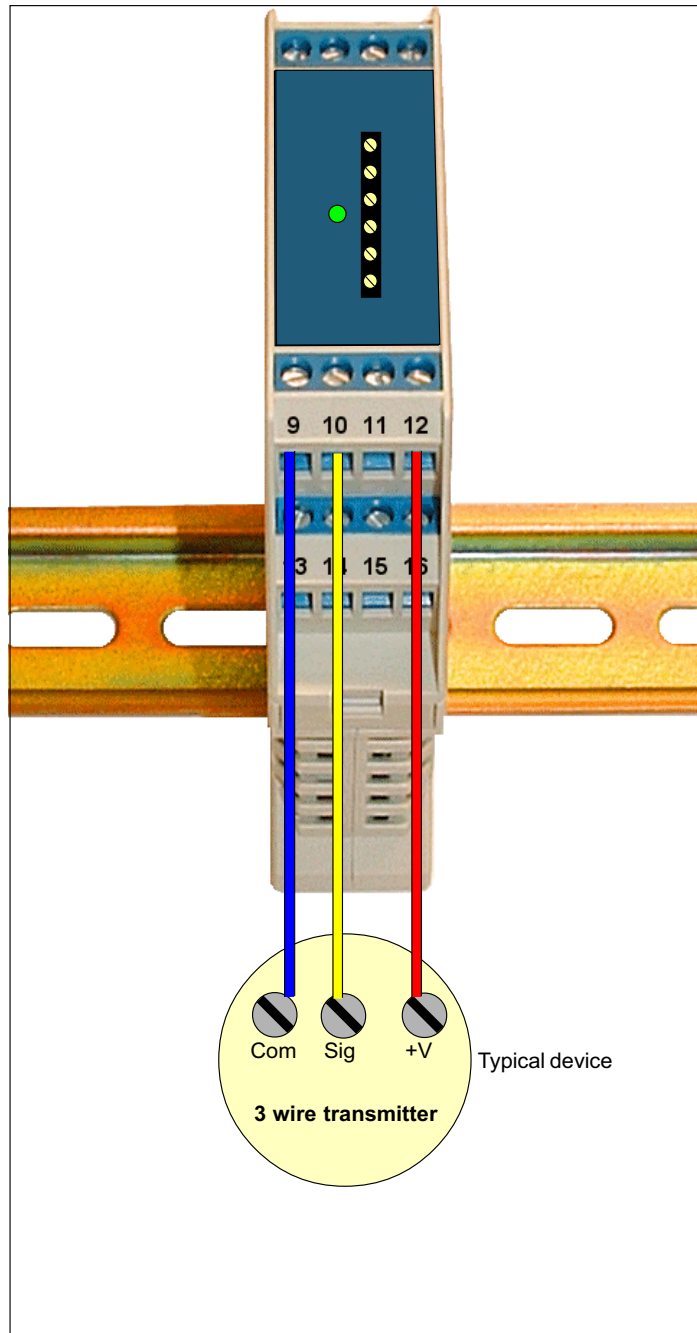



# DC Power

## Where to connect DC power to your loop splitter

First check the voltage rating on the silver label on the side of the loop splitter. It must say 11-30 VDC if you want to power your transmitter from a DC supply

**Notes:**

Terminal 13 = Earth / Ground

Terminal 14 = no connection

Terminal 15 = Positive

Terminal 16 = Negative

There is a 2A fuse in the splitter. You must fuse your power circuit 1A

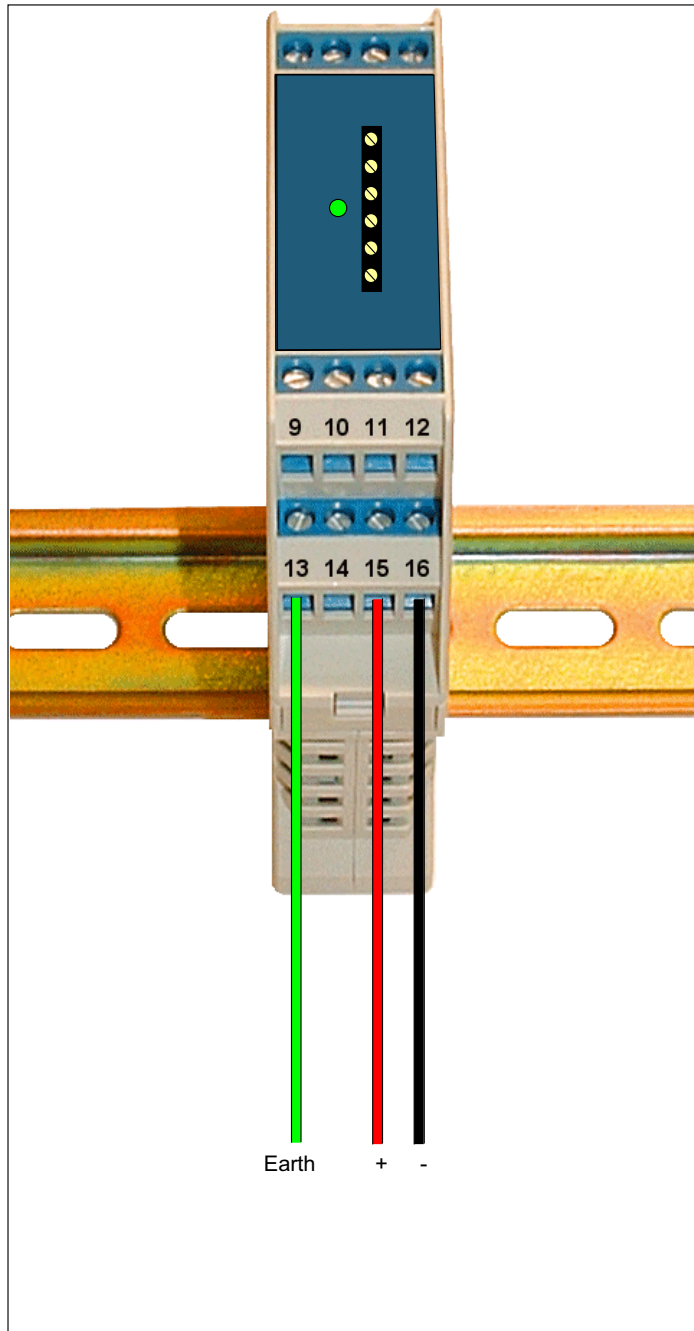

# 4-20mA outputs

## Where to connect 4-20ma outputs

Use screened twisted pair data cable. Keep data cable away from power cabling and noise to reduce interference to the data.

Terminal 4 is connected to terminal 6 and terminal 8 inside the splitter.

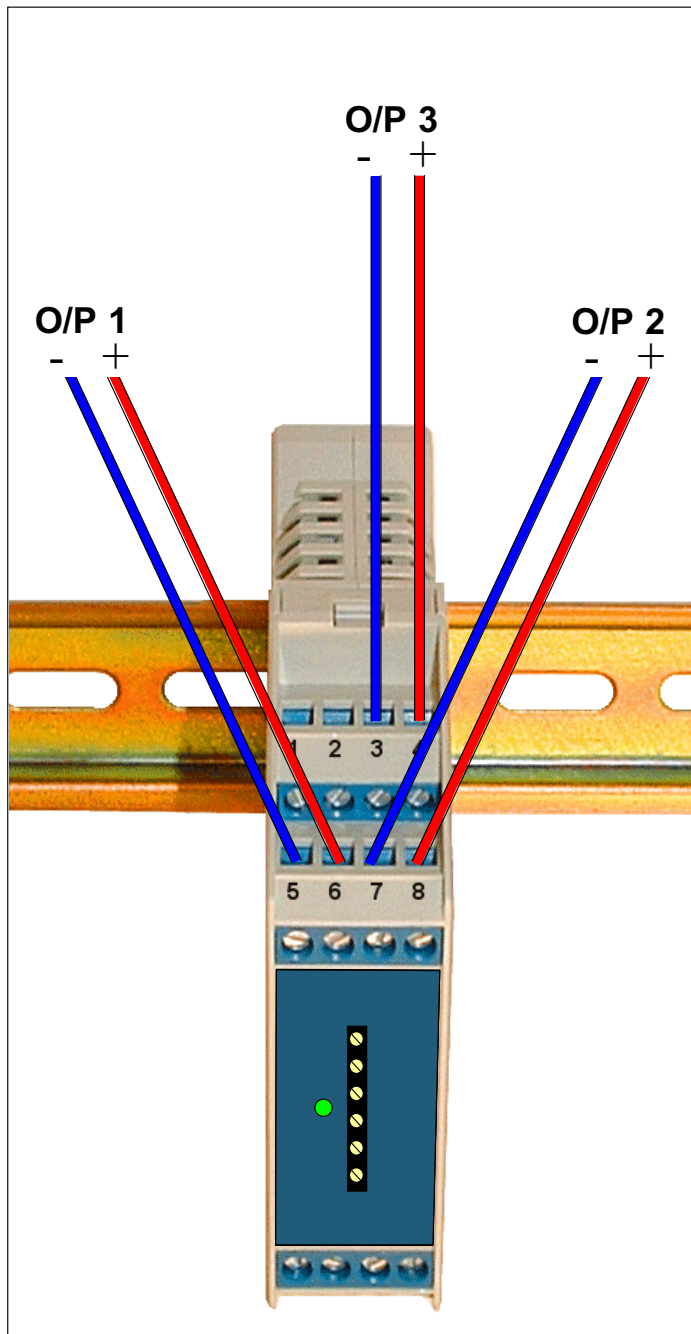

Notes: \_\_\_\_\_

Terminal 1 = not used \_\_\_\_\_

Terminal 2 = not used \_\_\_\_\_

Terminal 3 = O/P 3 - \_\_\_\_\_

Terminal 4 = O/P 3 + \_\_\_\_\_

Terminal 5 = O/P 1 - \_\_\_\_\_

Terminal 6 = O/P 1+ \_\_\_\_\_

Terminal 7 = O/P 2 - \_\_\_\_\_

Terminal 8 = O/P 2+ \_\_\_\_\_

Outputs can drive into 600 Ohms max. \_\_\_\_\_

at 20mA \_\_\_\_\_

All + outputs are commoned and are at \_\_\_\_\_

the same potential as Excitation + \_\_\_\_\_

\_\_\_\_\_

\_\_\_\_\_

\_\_\_\_\_

\_\_\_\_\_

\_\_\_\_\_

\_\_\_\_\_

\_\_\_\_\_

\_\_\_\_\_

\_\_\_\_\_

\_\_\_\_\_

\_\_\_\_\_

\_\_\_\_\_

\_\_\_\_\_

\_\_\_\_\_

\_\_\_\_\_

\_\_\_\_\_

\_\_\_\_\_

\_\_\_\_\_

\_\_\_\_\_

\_\_\_\_\_

\_\_\_\_\_

\_\_\_\_\_

# Calibration of each output.

1) Apply power, and leave the loop splitter running for a few minutes before commencing calibration.

2) Apply 4 mA to the input, and measure O/P 1. Adjust its zero pot to obtain 4mA output.

3) Apply 20 mA to the input and measure O/P 1. Adjust its span pot to obtain 20 mA output.

4) Repeat steps 2) & 3) until no further adjustment is needed.

5) Apply 12mA and check that the output is 12mA also.

6) Repeat steps 2 to 5 until no further adjustment is necessary, and then repeat the same procedure for outputs 2 and 3.

# Specifications

<b>Input Signal</b> .....	4-20mA
Input Resistance.....	50 Ohms
Resolution.....	infinite
Open Circuit Input Response.....	Downscale Drive
Speed of Response.....	< 100 mS
Accuracy.....	+/- 0.1% of span
Temperature stability.....	100 ppm of range/C span and zero
 <b>Outputs</b>	
Number of output channels.....	3
Loop drive capacity.....	600 Ohms per loop at 20mA
Span adjustability.....	+/- 9 mA at 20 mA input
Zero adjustability.....	+/- 1 mA at 4 mA input
Influence between outputs.....	Minimal. Any load conditions on one O/P has negligible effect on others
Ajustment location.....	On front face of transmitter, via access slot
Isolation.....	Isolated from ground, but not from input
 <b>Excitation Supply</b> .....	
Current Capacity.....	20 VDC nominal +/- 10% 30mA max. permissible load
 <b>Power Supply</b>	
AC Supply.....	95-265 VAC as standard. 11-30VDC optional
Current Consumption.....	Allow 3VA if excitation supply fully loaded.
 <b>Mechanical</b>	
Base size.....	22.5 mm wide by 99 mm high
Forward projection.....	111 mm
Weight.....	220 grammes
 <b>Environmental</b>	
Operating Temperature.....	0 to +50 degrees C
Storage Temperature.....	-20 to +70 degrees C
Humidity.....	10 to 90% rh max. at 40 C, non condensing.